



GT600

User Manual



THANKS FOR SELECTING A WIRELESS FIREFLY MICROSCOPE

To take full advantage of this product's advanced capabilities,
and to properly and safely use this product, please read the manual carefully.

Copyright 2011 by Firefly Global. All rights are reserved. No one is permitted to reproduce or duplicate, in any form, this manual or any part thereof without permission from Firefly Global (www.fireflyglobal.com).

Firefly Global assumes no responsibility for any injury, or for any illegal or improper use of the product, that may result from failure to use this product in accordance with the instructions, cautions, warnings, or indications for use published in this manual.

Software in this product is copyright of Firefly Global and its vendors. All rights are reserved. The software is protected by U.S. and international copyright laws and international treaty provisions applicable worldwide. Under such laws, the licensee is entitled to use the copy of the software incorporated with this instrument as intended in the operation of the product in which it is embedded. The software may not be copied, decompiled, reverse-engineered, disassembled or otherwise reduced to human-perceivable form. This is not a sale of the software or any copy of the software; all rights, title, and ownership of the software remain with Firefly and/or its vendors.

Caution: Changes or modifications not expressly approved by Firefly Global will void the purchaser's authority to operate the equipment and its warranty.

TABLE OF CONTENTS

Digital Microscope	1
Table of Contents.....	3
Introduction	5
Warnings & Cautions	6
Warning	6
Caution.....	6
Check List	8
Nomenclature	9
Operation.....	10
Setting up the software application :	10
Connect to PC :	10
Power the Device On :	10
Charging Battery:.....	11
Channel Mapping:	11
Using the Firefly Microscope System:.....	12
recommended holding position:	12
low ratio 10-100x:.....	12
high ratio >100x:.....	12
high ratio >100x:.....	13
Focus :	14
Brightness Adjustment:	14
Using Focus:.....	14
Using the image capture control:	15
Standby and Remove device:.....	15
Launch the Software Application:	16
Viewing the Images:	16
Tool bars	16
Tool bars	17
Control tool bars:	17
Image tool bars:	17
Device Tool bars:	18
Maintenance and Service.....	19
Cleaning recommendation.....	19
Recycling the system components	19
Accessories.....	19

Service policy 20

Specifications21

Limited Warranty22

Troubleshooting.....24

 Frequently Asked Questions (FAQs): 24

Wireless Interference Recommendations26

INTRODUCTION

The Wireless Firefly Microscope System consists of a wireless digital Microscope, a compact USB receiver, software application and a charge cable. Only a computer equipped with a free USB port is needed to use the system.

The Firefly Microscope System is designed for effective operation under a variety of conditions and typical video parameters are set at the factory. The software allows users to adjust most parameters including Saturation, Hue, Brightness, Contrast and Sharpness for desired applications.

System Requirements

The Wireless Firefly Microscope System requires a user PC system running Windows XP Service Pack 2 or later operating system, a viewing screen, and a PC with an available USB 1.1 or 2.0 port.

Intended use

Wireless Firefly Microscope System is intended to conveniently enable mobile inspection of objects.

User Profile

The Wireless Firefly Microscope System is intended for applications such as:

- Art / Watches / Jewelry inspection and repairs
- Electronic components inspection and repairs
- Coin examination for collectors
- Schools and Science Education
- Medical examinations
- Insect dissection and examination
- Plant anatomy inspection
- Skin test
- Textile inspection
- Industrial inspection
- Print Check

WARNINGS & CAUTIONS

Please familiarize all operating personnel with the general safety information in this summary. Specific warnings and cautions are also found throughout this manual.

Warning



A warning statement in this manual identifies a condition or practice which if not corrected or discontinued immediately, could lead to injury, illness, or death.

- Do not use in the presence of flammable anesthetics.
- This product has no user serviceable/replaceable parts. Please refer all service to authorized service personnel.
- This instrument is not intended to be used in the eye.
- This product generates and records reference images from inputs obtained from the software application FireflyPro. These reference images are not intended for medical or other diagnostic purposes.

Caution



A caution statement in this manual identifies condition or practice, which if not corrected or discontinued immediately, could lead to equipment failure, equipment damage, or data loss.

- In order to obtain optimum performance and ensure patient safety, thoroughly read this manual.
- Do not use the Wireless Firefly Microscope if you notice any signs of damage to the components of the system. Contact customer service for immediate assistance.
- Do not attempt to disinfect the Wireless Firefly Microscope System using glutaraldehyde products, ethylene oxide gas, steam or any other liquid or gas disinfectant.
- The signal output (USB Port) connector is intended for connection of only devices complying with IEC 60601-1, or other IEC standards (for example, IEC 60950), as appropriate to the device. Connecting additional devices to the Wireless Firefly Microscope System is not allowed. You are

responsible for verifying that the system complies with the requirements of the system standard IEC 60601-1-1.



- This product complies with current required standards for electromagnetic interference and should not present problems to other equipment or be affected by other devices. As a precaution, avoid using this device in close proximity to other equipment.
- Do not apply alcohol, chemicals, or water to the lens. Any liquids entering the optical assembly will damage internal components.

CHECK LIST

Before starting, check that all the following items have been included with your product. If anything is missing, contact your dealer.

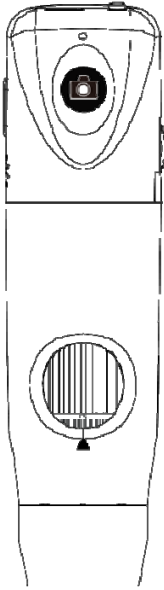

Microscope x 1pc

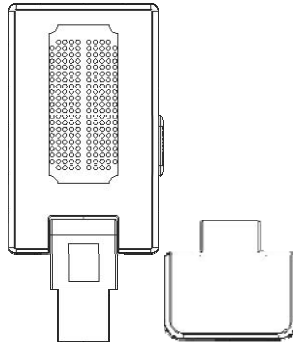

Receiver x 1 pc

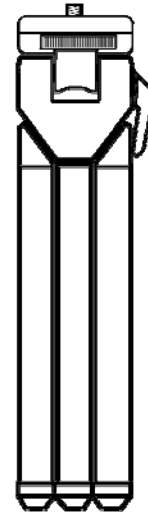

Tripod x 1 pc

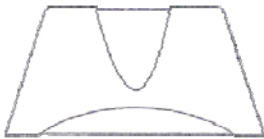

Stand Holder x 1 pc



Power Adapter x 1pc
100-240V AC to 5V USB DC
Notice: Actual Shape may vary.



Software Application CD



Clip x 1 pc

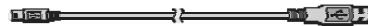

USB DC power cord x 1 pc

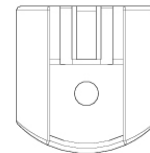

Tripod Adapter x 1pc

NOMENCLATURE

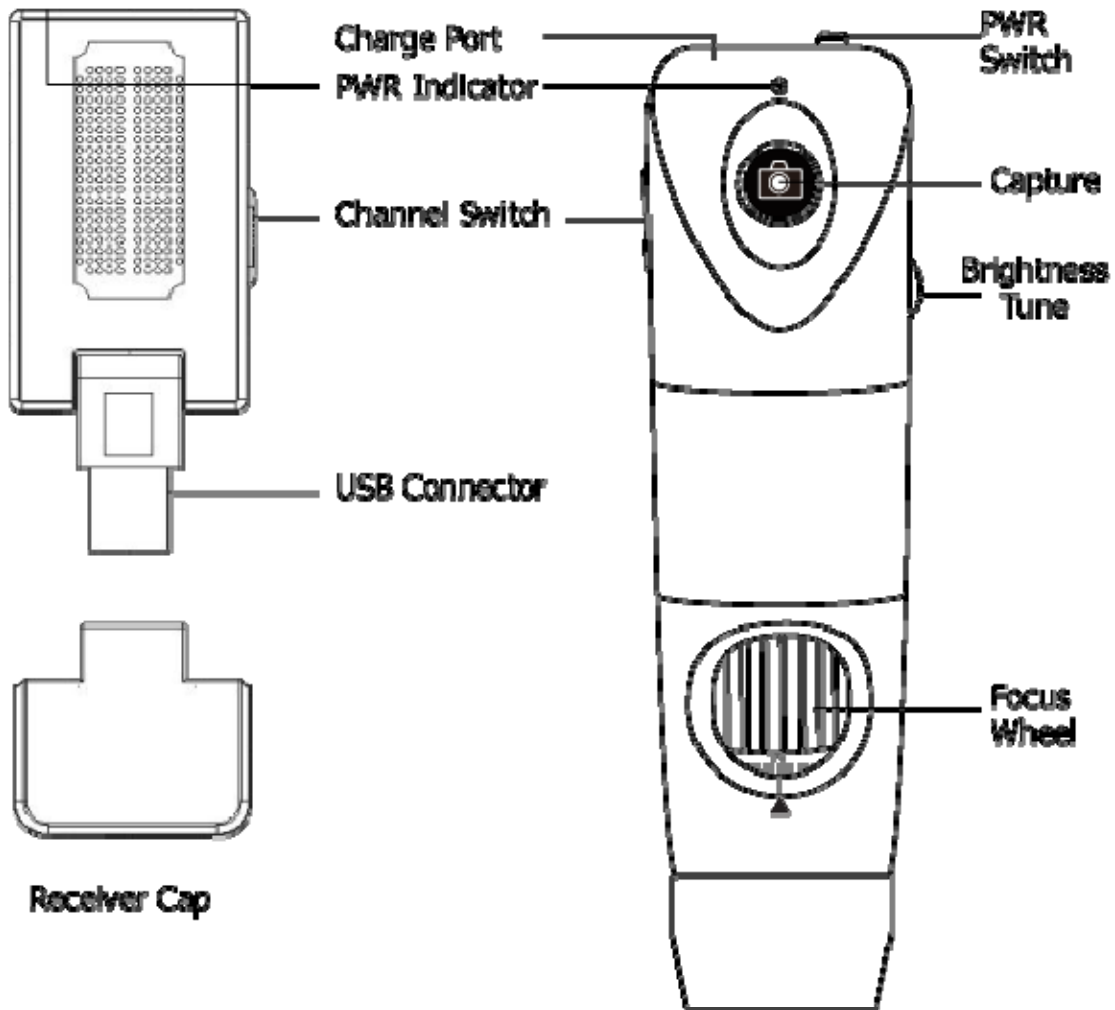

OPERATION

To obtain a clear image, please grip the Firefly Microscope; remain still and avoid vibration as much as possible during observation.

Setting up the software application :

Prior to using the Firefly Microscope for the first time, install the FireflyPro software application following the instructions provided with the installation CD.

Connect to PC :

Connect the compact receiver to the PC's USB port

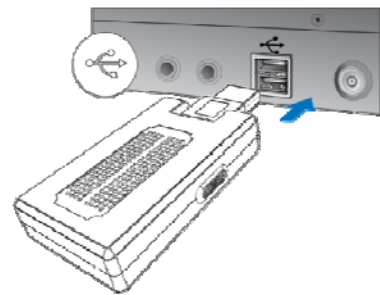

Power the Device On :

Push the 'Power Button' at the rear of the microscope to activate the device. An indicator light will turn on to confirm the power status.

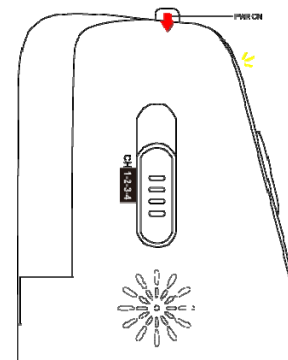
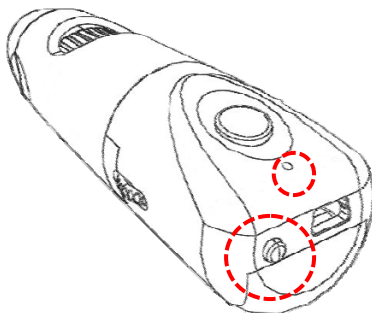

Charging Battery:

■ Duration:

The Wireless Firefly Microscope has a built-in high efficiency lithium battery that enables more than 4.5 hours continuous operation.

■ Charging the Battery:

Through the mini-USB port at the rear of the microscope, the embedded battery can be charged with the provided USB DC cable. The cable must be connected to the USB port of a PC or to the "USB Power Adapter", which can charge directly from a wall outlet.

■ Overload Protection:

The overload protection circuit will prevent overcharging when the battery is full and the "Indicator" will turn green.

■ Power Indication:

The power indicator light is normally red during operation, but it will turn blue when the remaining battery life is less than 30 minutes.



The lithium battery is a delicate and consumable item. It is expected to last through years of use and is guaranteed for twelve months from its purchase against defects. If there is any battery related issue, please contact customer service immediately. Battery replacement by unauthorized personnel or replacement with unauthorized batteries may damage the system and voids the overall warranty.

Channel Mapping:

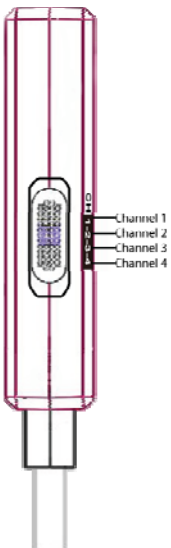

On the rear right side of the microscope, there is a switch allowing users to set the wireless channel. Both the receiver and microscope must be set to the same channel for proper operation:

- ◆ CH 1: 2.4GHz channel 1
- ◆ CH 2: 2.4GHz channel 2
- ◆ CH 3: 2.4GHz channel 3
- ◆ CH 4: 2.4GHz channel 4

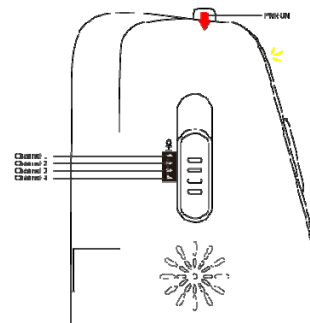

Using the Firefly Microscope System:

recommended holding position:

It is suggested to hold the microscope, transparent cover forward, with the thumb held on the equipment. This holding position offers relative stability and allows lens control. The index finger is still free to rotate and adjust the focus wheel (as shown).

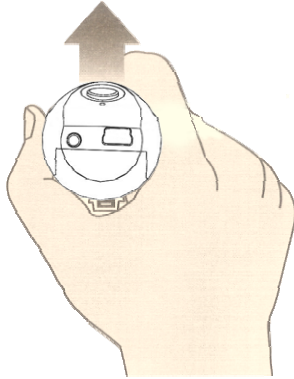

low ratio 10-100x:

The digital microscope is placed in the "Base". The open viewing area at the bottom of the base allows placement of samples under the microscope for observation.

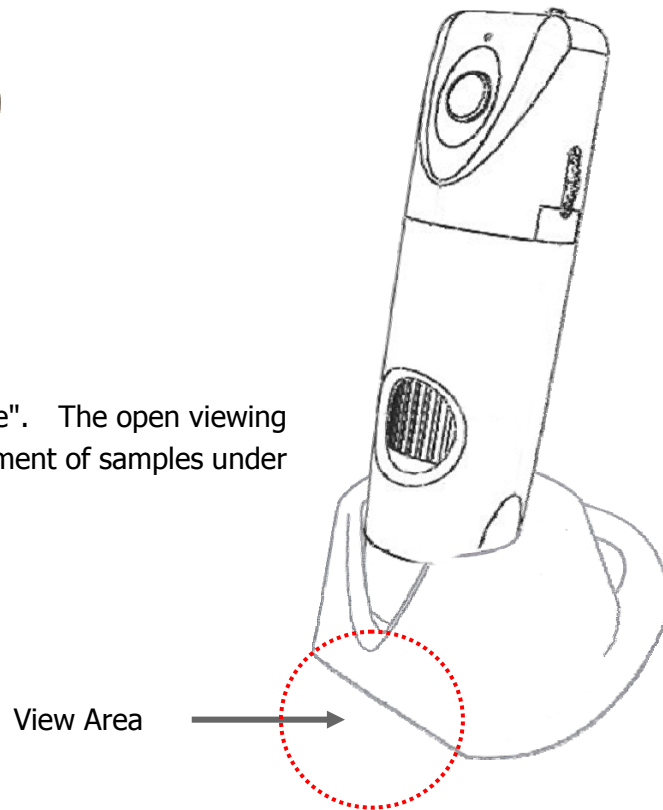

high ratio >100x:

When there is a need to zoom in more than 100 times, maintaining body stability becomes more paramount. In such instances, a microscope stand is recommended. When a stand is not available, it is suggested that the digital microscope focus wheel opening should be placed towards the user, and the transparent cover vertically downward. This enables easy access to the focus wheel and a very stable position. A smooth desktop may be used as an observation platform. (Shown below)

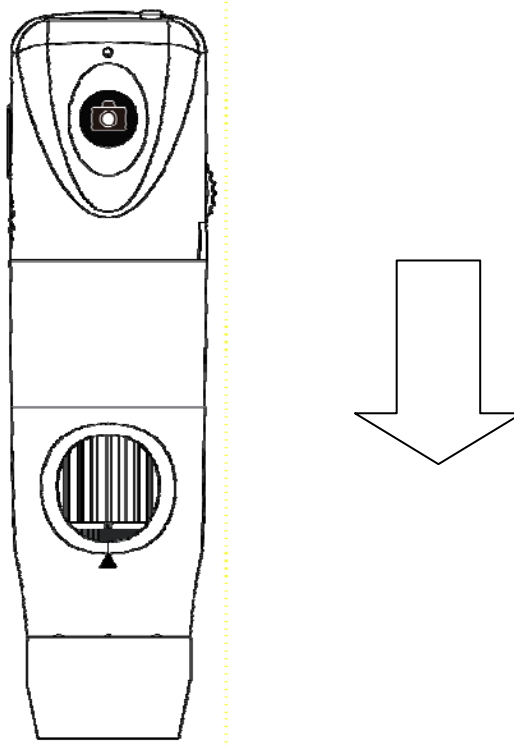

Device vertically downward (stable observation)

Focus :

Based on the relative height of the observed object, the focus wheel can be turned for a clear image. When a higher magnification is required, the focus wheel can be turned to the left (see below). If a larger field of view is required, the microscope can be moved farther away and the focus wheel turned to the right.

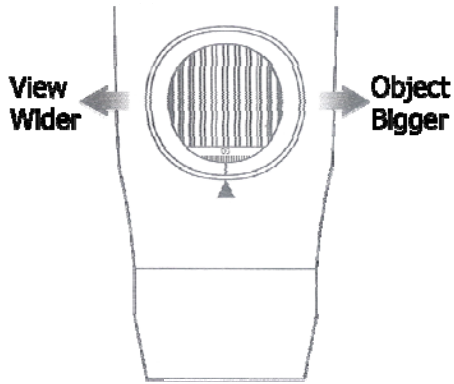

Brightness Adjustment:

On left rear side of the microscope, a knob allows the user to control brightness of the LEDs:

- ◆ Backward Turn: Decrease Brightness
- ◆ Forward Turn: Increase Brightness

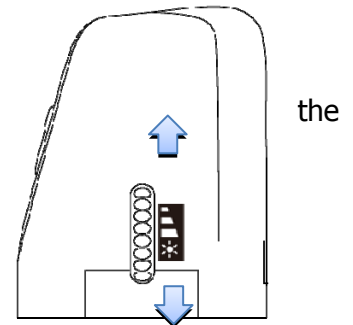

Using Focus:

Default Position: Match the scale 50 to arrow mark.

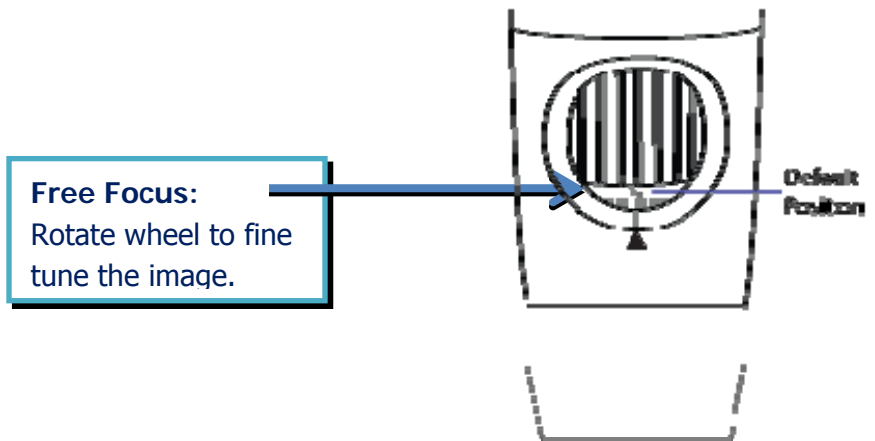

Using the image capture control:

Press and release the Capture button to capture image frames. The system will generate a shutter sound from the PC speaker as confirmation.

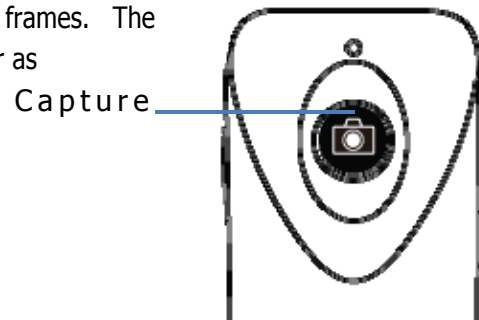

Standby and Remove device:

To temporarily turn off or remove the device, push and release the power button to the "OFF" position. The device must also be turned off through the Windows operating system:

- On your Microsoft Windows Desktop, click My Computer in the left pane. Double-click the USB Video Device (Wireless Digital Microscope in Windows Vista and Windows 7).

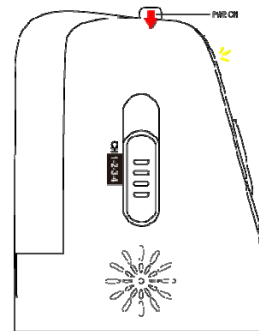

After turning off the device through Windows above, the compact receiver can be unplugged from the PC's USB port. Using this sequence will avoid transient voltages from potentially causing hardware damage.

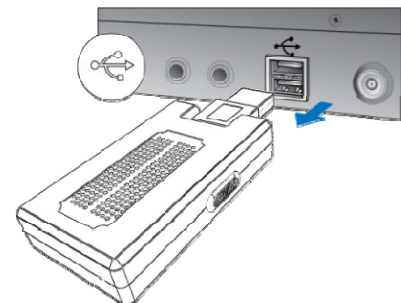

Launch the Software Application:

Double-click the FireflyPro.exe icon on your computer desktop:



Viewing the Images:

FireflyPro software controls your Firefly Microscope. The Microscope communicates with the PC through the USB compact receiver. The user can configure the video properties, review live images, capture images, record video clips and perform a variety of powerful measurement and documentation functions.

The main features of FireflyPro are shown below:

Main Window Display

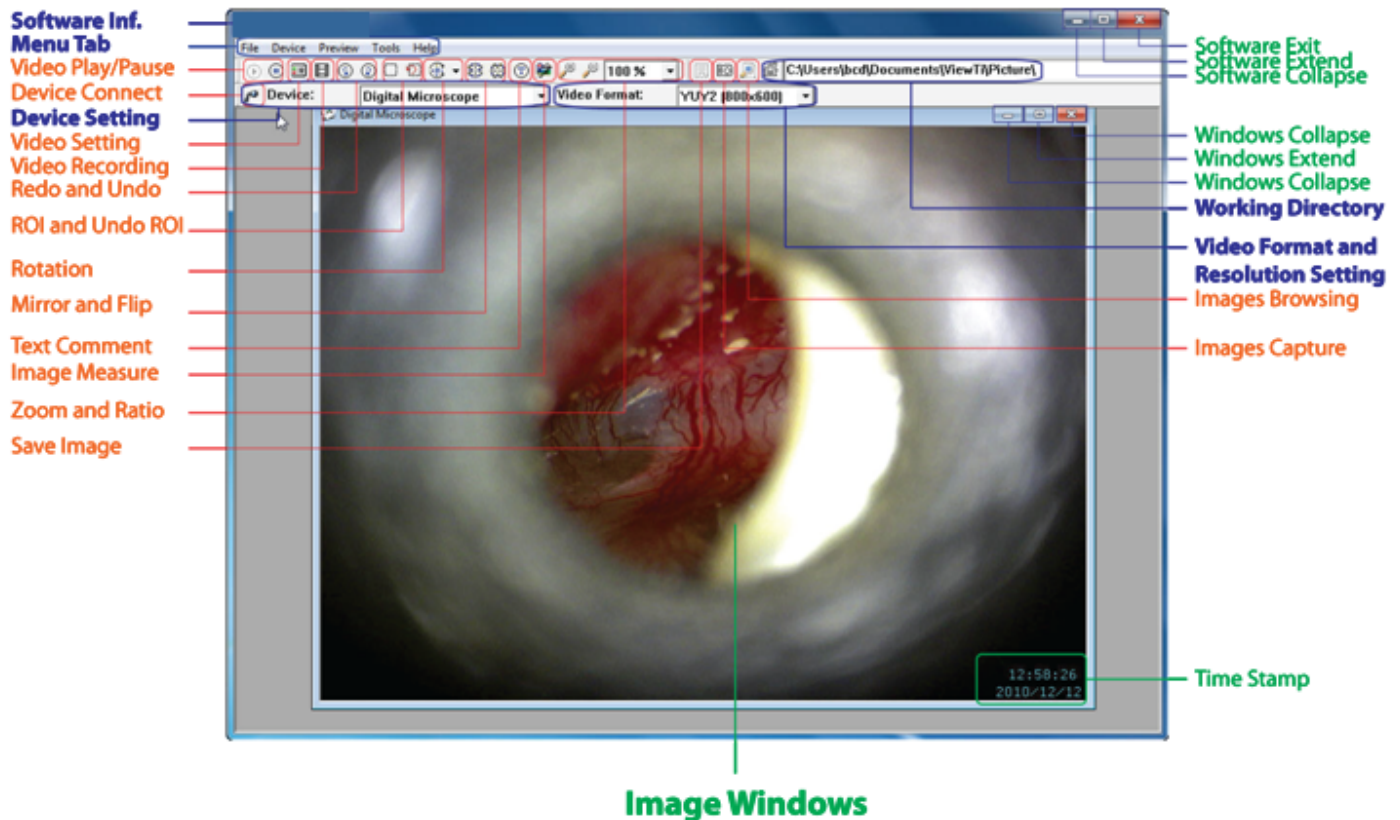

Tool bars

The Tools bars enable quick access to the functions of FireflyPro software. The tool bars can be grouped into Control, Images and Device tool bar sets.

Control tool bars:



Icon	Icon Name	Function Description
	Play	Start the video stream preview
	Pause	Freeze live video image frame
	Video Setting	Configure video properties
	Video Recording	Video recording and settings (frame, period, quality, codec etc...)
	Undo	Undo the previous Rotation, Text Comment and Zoom
	Redo	Redo the previous Rotation, Text Comment and Zoom
	ROI	Select region of interest (ROI) on live video stream
	Undo ROI	Revoke ROI selection
	Rotation	Rotate live video 0°, 90°, 180°, 270°
	Mirror	Mirror live video horizontally
	Flip	Flip live video vertically
	Text Comment	Add text layer on image
	Image Measure	Launch image measurement application
	Zoom +	Zoom-in live video up to 300%
	Zoom -	Zoom-out live video down to 10%
	Zoom Ratio	Set Zoom ratio from 10-300

Image tool bars:

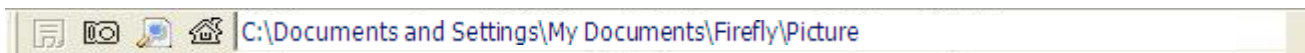



Icon	Icon Name	Function Description
	Save Image	Store frozen image
	Image Capture	Capture and store instant image from live video
	Image Browsing	Browse images in working directory
	Working Directory	Pop-up to select working directory path

[C:\Documents and Settings\My Documents\Firefly\Picture](#) Edit working directory path

Device Tool bars:

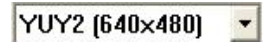

Icon	Icon Name	Function Description
	Device Connect	Refresh image device connection
	Digital Microscope	Select available image devices, such as Microscope
	YUY2 (640x480)	Select a video format (default 640x480 YUY2)

MAINTENANCE AND SERVICE

Cleaning recommendation



CAUTION Do not apply alcohol, chemicals, or water to the lens. Any liquids entering the optical assembly will damage internal components.

Use a dry cloth to clean the Digital Firefly Microscope System on a weekly basis.

Recycling the system components

Within the EU



Do not dispose of this product as unsorted municipal refuse. Submit for separate collection as specified by Directive 2002/96/EC of the European Parliament and the Council of the European Union on Waste Electronic and Electrical Equipment (WEEE).

If this product is contaminated, this directive does not apply. For more specific disposal information contact Customer Service.

Outside the EU

When the product and its components reach end of life, recycle the product according to national, state, and local regulations.

Accessories

REF	Description
FY-MU-50	USB Charge Cord, 50cm length
GT600RU	USB Compact Receiver for PC
GT600RV	USB Compact Receiver for Video
FY-PWR-USB	100-240V AC to 5V DC USB >0.8A

Service policy

All repairs on products under warranty must be performed or approved by Firefly or its authorized resellers. Unauthorized repairs will void the warranty. In addition, whether or not covered under warranty, any product repair shall exclusively be performed by Firefly-certified service personnel.

If the product fails to function properly — or if you need assistance, service, or spare parts — contact your Firefly reseller.

Before contacting your reseller, try to duplicate the problem and check all accessories to ensure that they are not causing the problem. When calling, please be prepared to provide:

- ◆ Product name and model number and complete description of the problem.
- ◆ Serial number of your product (if applicable).
- ◆ Complete name, address and phone number of your facility.
- ◆ For out-of-warranty repairs or spare parts orders, a purchase order (or credit card) number.
- ◆ For parts orders, the required spare or replacement part numbers.

If your product requires warranty, extended warranty, or non-warranty repair service, please contact your Firefly reseller. A customer service representative will assist you in troubleshooting the problem and will make every effort to solve it over the phone, avoiding potential unnecessary returns. In case a return cannot be avoided, the representative will record all necessary information and will provide a Return Authorization number, as well as the appropriate shipping address. The Return Authorization number must be obtained prior to any return.

If you have to return your product for service, follow these recommended packing instructions:

- ◆ Disconnect all hoses, cables, sensors, power cords, and ancillary products (as appropriate) before packing, unless you suspect they are associated with the problem.
- ◆ Wherever possible use the original shipping carton and packing materials.
- ◆ Include a packing list and the Return Authorization number.

It is recommended that all returned goods be insured. Claims for loss or damage to the product are the responsibility of the sender.

SPECIFICATIONS

Item	Specification
Weight	Approximately 100 g (0.22 lb)
Dimensions (approximate)	Length: 11.4 cm (4.5 inches) Height: 3.7. cm (1.5 inches) Width: 3.7 cm (1.5 inches)
Ratio	USB 5 VDC, 150mA
Protection against ingress of water	IPXØ
Operating conditions	
Temperature	+10°C to +40° C (+50°F to +104°F)
Relative humidity	30% to 75% noncondensing
Altitude	700 to 1060 hPa
Shipping and storage conditions	
Temperature	-20°C to +49°C (-4°F to +120°F)
Relative humidity	95% noncondensing max.
Wireless	Implemented with 2.4 GHz Technology
Power consumption	Less than 10mW
Sensitivity	-87dBm
Noise ratio	47dBm
Antennae resistance	50Ω
Channel spectrum	4 channels range from 2410 to 2470 MHz
Coverage	Longer than 5 meters (15ft) on open field
Battery (Lithium battery)	More than 4.5 hours continuous usage
Capacity	700mAh (Lithium battery)
Service	Authorized personnel only
Safety Compliance	FCC, CE and RoHS compliant
Patent	Patent Pending

LIMITED WARRANTY

Limited Hardware Warranty (through distributors & resellers)

FireFly Global hardware products purchased in the U.S. come with a 1-year limited hardware warranty. The warranty is extended through Firefly Global authorized representatives and resellers. If you have a warranty claim, please contact the store, distributor, or website through which the product was purchased.

What is covered by this limited hardware warranty?

This limited hardware warranty covers defects in materials and workmanship in your FireFly Global hardware products.

What is not covered by this limited hardware warranty?

This limited hardware warranty does not cover:

- Software, including the operating system and software added to or bundled with the FireFly Global hardware products
- Problems that result from:
 - External causes such as accident, abuse, misuse, or problems with electrical power
 - Servicing not authorized by FireFly Global
 - Usage that is not in accordance with product instructions
 - Failure to follow the product instructions
 - Problems caused by using accessories, parts, or components not supplied by FireFly Global
- Products with missing or altered serial numbers
- Products for which FireFly Global or its distributors have not received payment
- Normal wear and tear

THIS WARRANTY GIVES YOU SPECIFIC LEGAL RIGHTS, AND YOU MAY ALSO HAVE OTHER RIGHTS WHICH VARY FROM STATE TO STATE (OR JURISDICTION TO JURISDICTION). FIREFLY GLOBAL'S RESPONSIBILITY FOR MALFUNCTIONS AND DEFECTS IN HARDWARE IS LIMITED TO REPAIR AND REPLACEMENT AS SET FORTH IN THIS WARRANTY STATEMENT. ALL EXPRESS AND IMPLIED WARRANTIES FOR THE PRODUCT, INCLUDING BUT NOT LIMITED TO ANY IMPLIED WARRANTIES AND CONDITIONS OF MERCHANTABILITY AND FITNESS FOR A PARTICULAR PURPOSE, ARE LIMITED IN TIME TO THE TERM OF THE LIMITED WARRANTY PERIOD REFLECTED ON YOUR PACKING SLIP OR INVOICE. NO WARRANTIES, WHETHER EXPRESS OR IMPLIED, WILL APPLY AFTER THE LIMITED WARRANTY PERIOD HAS EXPIRED. SOME STATES DO NOT ALLOW LIMITATIONS ON HOW LONG AN IMPLIED WARRANTY LASTS, SO THIS LIMITATION MAY NOT APPLY TO YOU.

WE DO NOT ACCEPT LIABILITY BEYOND THE REMEDIES PROVIDED FOR IN THIS LIMITED HARDWARE WARRANTY OR FOR CONSEQUENTIAL OR INCIDENTAL DAMAGES, INCLUDING, WITHOUT LIMITATION, ANY LIABILITY FOR THIRD-PARTY CLAIMS AGAINST YOU FOR DAMAGES, FOR PRODUCTS NOT BEING AVAILABLE FOR USE, OR FOR LOST DATA OR LOST SOFTWARE. OUR

LIABILITY WILL BE NO MORE THAN THE AMOUNT YOU PAID FOR THE PRODUCT THAT IS THE SUBJECT OF A CLAIM. THIS IS THE MAXIMUM AMOUNT FOR WHICH WE ARE RESPONSIBLE.

How long does this limited hardware warranty last?

The limited hardware warranty on all FireFly Global products begins on the date of the packing slip, invoice, or receipt. The warranty period is not extended if a warranted product or any parts are repaired or replaced. FireFly Global may change the availability of limited hardware warranties, at its discretion, but any changes will not be retroactive.

What do I do if I need warranty service?

Before the warranty expires, please contact the store, distributor, or website through which the product was purchased.

What will FireFly Global do?

FireFly Global or its authorized representative or reseller will repair any FireFly Global hardware products returned that prove to be defective in materials or workmanship. If FireFly Global or its authorized representative are not able to repair the product, we will replace it with a comparable product that is new or refurbished.

When you contact our authorized representatives or resellers via phone or email, they will issue a Return Material Authorization Number for you to include with your return. You must return the products in their original or equivalent packaging, prepay shipping charges, and insure the shipment or accept the risk if the product is lost or damaged in shipment. The repaired or replacement products will be returned to you. The reseller or authorized representative will pay to ship the repaired or replaced products to you if you use an address in the United States (excluding Puerto Rico and U.S. possessions and territories). Otherwise, the product will be shipped to you freight collect.

If it is determined that the problem is not covered under this warranty, you will be notified and informed of service alternatives that are available to you on a fee basis.

How will you fix my product?

We use new and refurbished parts made by various manufacturers in performing warranty repairs and in building replacement parts and systems. Refurbished parts and systems are parts or systems that have been returned to FireFly Global, some of which were never used by a customer. All parts and systems are inspected and tested for quality. Replacement parts and systems are covered for the remaining period of the limited hardware warranty for the product you bought. FireFly Global owns all parts removed from repaired products.

May I transfer the limited hardware warranty?

Limited hardware warranties are not transferable.

TROUBLESHOOTING

Frequently Asked Questions (FAQs):

Q1. What do I do if my Firefly Microscope and FireflyPro software suddenly stops working?

Answer:

- a) Shutdown the Firefly Microscope and disconnect the USB data cable from the computer.
- b) Close the FireflyPro software.
- c) Wait for one minute, reconnect the USB data cord to system and switch the Microscope on.
- d) Double-click the FireflyPro icon on desktop to launch the software application again.

Q2. When using the first version of Vista (not Vista SP1), there is a black visible region that randomly appears, what can I do to fix this?

Answer:

Please update Windows Vista through Microsoft update, or click Toolbar - "Set -" default" – "OK" to refresh the display.

Q3. What do I do when my computer is woken-up from standby or hibernation and FireflyPro software stops working?

Answer:

Please close and try restarting the software application again.

Q4. Why is there no image displayed on FireflyPro image windows?

Answer:

- a. Please verify whether the device is connected properly
- b. Please switch the Microscope device "OFF" and back to either "LED1" or "LED2"

Q5. The Microscope is connected to the PC, but why can it not be used?

Answer:

- a. Make sure the FireflyPro software is installed completely and properly.
- b. Please verify whether the device is connected properly
- c. Make sure the compact receiver is connected to the PC's USB port.
- d. Please unplug the compact receiver and plug into the PC's USB port again.

Q6. How do I uninstall the FireflyPro software?

Answer:

To uninstall, go to Start -> Settings -> Control Panel -> Programs and Features -> Uninstall

Q7. Why does the video stream appear like a mosaic and update slowly (or not smoothly)?

Answer:

- a. Too many software programs may be running simultaneously and overloading the CPU, or the physical memory has reached its saturation. Please close unnecessary programs. If video stream doesn't improve, please reboot the system in order to release previously used memory.

b. Check whether the system is infected by a virus.

c. The PC may be too old to properly drive the video stream and does not meet the minimum standards set forth in the instructions. Please use faster system.

Q8. What to do if the FireflyPro software application crashes?

Answer:

If the system crashes, disconnect the USB data cable and switch off the Microscope. Re-boot the PC and, after system reboot, reconnect the Microscope, switch on and restart the FireflyPro application.

WIRELESS INTERFERENCE RECOMMENDATIONS

Last reviewed: January 27, 2011.

Many wireless products, such as cordless phones, home networks, Bluetooth devices, and baby monitors, share the 2.4-GigaHertz (GHz) radio frequency bands. As a result, these products are likely to interfere with each other. Interference might generate noisy images and degrade the video quality on the Wireless Firefly Microscope.

Here's what you need to know to minimize interference:

Interference immunity from cordless phones

Most 2.4GHz cordless phones use frequency hopping spread spectrum (FHSS) technology that operates within the 2.4-GHz spectrum. FHSS hops from frequency-to-frequency across the entire 2.4GHz spectrum. The wireless Firefly Microscope and 802.11 WiFi wireless networks, on the other hand, use direct sequence spread spectrum (DSSS), which transmits within only a part of the 2.4 GHz spectrum. Because FHSS jumps across the entire spectrum while DSSS stays in only one portion, a FHSS 2.4GHz product can cause interference with the Wireless Firefly Microscope.

Choose a cordless phone that uses the 5.8-GHz, 1.9-GHz, or 900-MHz band

These frequency bands are not as widely used as 2.4-GHz and, therefore, are less likely to cause or receive interference. If you want a multiple-handset-capable cordless phone with handset-conferencing capability, choose one that uses only the 5.8-GHz or 1.9 GHz band. By contrast, nearly all phones using 2.4-GHz digital spread spectrum (DSS) technology and those that allow handset conferencing may create interference in other products, some even while in standby mode. Be aware that some cordless phones labeled as 5.8-GHz actually use both the 5.8-GHz and 2.4-GHz bands. DSS phones labeled as "wireless network friendly" or "802.11-friendly" are unlikely to interfere with wireless computer networks, but they may interfere with the Wireless Firefly Microscope and other wireless devices. Keep the 2.4-GHz analog phones as far away from the area as possible.

Lower the antenna position of cordless phone

If relocating or replacing the phone is not an immediate option, operate the cordless phone with the antenna in the lowered position if possible. This will dampen the RF signal coming from the cordless phone and reduce the amount of interference.

Keep your distance

After above adjustment, try keeping the conflicting cordless phone as far away as possible, such as in different rooms.

Interference immunity from wireless networks

Like most wireless products, the wireless Firefly Microscope allows you to operate at 4 separate channels (residing on frequency range index of 2414, 2432, 2450 or 2468±10 MHz).

The 802.11 wireless networks use direct sequence spread spectrum (DSSS), which transmits within approximately one third of the 2.4 GHz spectrum, and it is possible to change the channels of 802.11 networks on a wireless router by entering the administration mode.

Change Access Point or Wireless Router channels

Normally the WiFi wireless network router or access point uses #6 as the default channel, which is located in the center of the 2.4-GHz spectrum. This can easily conflict with the wireless Firefly Microscope's spectrum. Try changing the channel on the access point (i.e. 1, 6, and 11). Anecdotally, users have found they have the least interference on channel 11 while the wireless Firefly Microscope's channels are set to 3 or 4.

Change the relative location of the Access Point

Maximize the distance between the wireless Microscope and WiFi devices.

Fine tune the position of the compact receiver

Try different angles on the compact receiver. A flat horizontal orientation or vertical orientation may produce better results.

Interference is an unfortunate byproduct of numerous wireless products today. While there are no guarantees the actions above will work, they may reduce interference to acceptable levels.



Öä d ä ~ ç ä Å ^ K



100 Lauman Lane, Suite A, Hicksville, NY 11801
Tel: (877) 877-7274 | Fax: (516) 801-2046
Email: Info@nyscopes.com
www.microscopeinternational.com